

2025  
**PONTIAC TRAIL**<sup>®</sup>  
HOME DETAILS TO LIVE BY



SHUTTERS | BLOCKS | VENTS  
**MODERNIZED SIDING ACCESSORIES**



Standard  
Mounting Block

Standard Mounting  
Block w/ Universal  
Electrical Box

Pontiac Trail's mission is to maximize the joy associated with selling, installing, and living in a home that features our products by providing **simple yet elegant design solutions.**

## MODERNIZED SIDING ACCESSORIES

**We're offering a fresh perspective on the siding accessory market with premium appearances & intuitive designs in a streamlined product portfolio.**

# SHUTTER OFFERING

Decorative shutters for exterior windows

## Raised Panel

14.5" & 12" widths



## Open Louver

14.5" & 12" widths



## Board & Batten\*

4 board (14.5") &  
3 board (11") widths



Available in the following standard heights: 31", 35", 39", 43", 47", 51", 55", 59", 63", 67", 71", 75", 81"

Includes shutter plugs and screws & caps | Limited lifetime warranty | Made in the USA

Available in 9 standard colors | Custom heights available: 28-81" in 0.50" increments

Shutter colors shown are Navy Night Sky (104) & Cornerstone Grey (410)

\* Board & Batten has 2 battens on heights 31"- 54.5" and 3 battens on 55" and larger

# SIZING YOUR SHUTTERS IS EASY

## SELECTING SHUTTER WIDTHS

Window width over 24": Use 14.5" shutter

Window width under 24": Use narrow width (11" or 12")

Mixing shutter widths on a house can create a custom, elegant look.



## SELECTING SHUTTER HEIGHTS

There are many ways to position shutters on a window:

**Shutter Size:** Size of window opening  
**Position:** Outside window opening

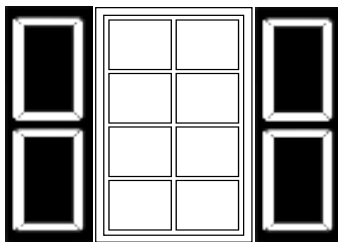

**Shutter Size:** Size of window opening  
**Position:** Over window trim

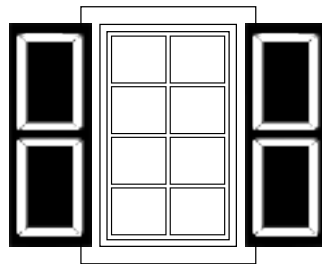

**Shutter Size:** Size of window trim  
**Position:** Outside window trim

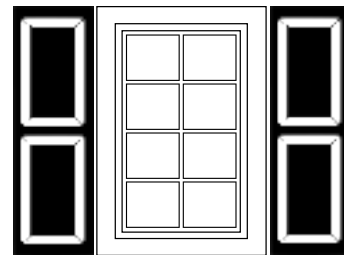

When selecting a standard height shutter, choose the size that is closest to the window trim or opening size. If the height falls between two standard shutter heights, select the larger size.



### SIZING TIPS

Examples to help you select the right shutter width and height for your window.

# OUR BOARD & BATTEN SHUTTER INSTALLS QUICKLY ON SIDING

A premium appearance that is fast and straightforward to install.

## EXPANSION SLOTS FOR SCREWS

Our board and batten shutters feature molded expansion slots for quick installation on siding: no pre-drilling or measurements necessary. Note: For brick applications, shutter plugs are recommended.

**CAN INSTALL WITH AN IMPACT DRIVER**



## SNAP-IN BATTENS CONCEAL THE FASTENERS

After fastening with screws, simply snap the batten into the shutter base. This design conceals the fasteners, allowing you to complete the job quickly and neatly.



### EASY TO INSTALL

See how simple installation is on our Board & Batten Shutters.

# PAINABLE SHUTTERS

Both Black Cosmos (050) and Dover White (930) are paintable, making them ideal choices when a custom color is desired.



**PAINTING TIPS**  
See how to get the best results painting shutters.

# MOUNTING BLOCK OFFERING



**Standard  
Mounting Block**

**8" x 9"**  
Outer Dimension



Receptacles,  
exterior lights,  
security cameras,  
and more



Accepts the  
Universal Electrical Box

**0.75"-1.5"** pocket  
depths  
to be used with:  
• Siding (0.75")  
• Polymer Shake (1")  
• Insulated Siding (1.25"-1.5")



**Large  
Mounting Block**

**8" x 13"**  
Outer Dimension



Coach lights, HE  
furnace penetrations,  
and more



Accepts the  
Universal Electrical Box

**0.75"-1.5"** pocket  
depths  
to be used with:  
• Siding (0.75")  
• Polymer Shake (1")  
• Insulated Siding (1.25"-1.5")



**Split  
Mounting Block**

**7.75" x 9.5"**  
Outer Dimension



Hose penetrations,  
existing receptacles,  
AC lines, and more



—

**0.75"-1.5"** pocket  
depths  
to be used with:  
• Siding (0.75")  
• Polymer Shake (1")  
• Insulated Siding (1.25"-1.5")

**Mounting Blocks are individually wrapped in a 6 pack box**  
for clean jobsite arrival

# DESIGNED WITH FUNCTIONALITY IN MIND

Focusing on usability, we developed a streamlined offering that enhances the experience for distributors, installers, and homeowners alike.

## INDIVIDUALLY WRAPPED

Mounting Blocks & the Universal Electrical Box are individually wrapped to ensure the product arrives to the jobsite clean.



## PERFECT ACCENT FOR ALL SIDING

Our Blocks and Vents feature a stippled finish that complements your siding, regardless of its texture. Plus, we have color matches for nearly every major siding manufacturer.

---

## DIMENSIONS

---

Standard Mounting Block



Large Mounting Block



Split Mounting Block



# STANDARD MOUNTING BLOCK

Applications: Receptacles, Exterior Lights, Security Cameras, and more



**8" x 9"**  
Outer Dimension



Accepts the  
Universal Electrical Box

**0.75"-1.5"** pocket depths  
to be used with:  
• Siding (0.75")  
• Polymer Shake (1")  
• Insulated Siding (1.25"-1.5")

**Individually wrapped  
in a 6 pack box**  
for clean jobsite arrival

## THE ULTIMATE SNAP-FIT FEEL (ALL BLOCKS & VENTS)



Our patented snap-fit design installs with a satisfying click you can both hear and feel. Special grooves in our trim-ring, combined with a larger locking tooth, deliver a premium snap-fit experience.

## WIDE TRIM-RING (ALL MOUNTING BLOCKS)



Our trim-ring is the widest in the industry, extending 1.25" from the block edge to fully cover siding cuts. Its broader design makes cut tolerances less critical, simplifying the installation process.

# LARGE MOUNTING BLOCK

Applications: Coach Lights, HE Furnace Penetrations, Exterior Lights, and more



**8" x 13"**  
Outer Dimension



Accepts the  
Universal Electrical Box

**0.75"-1.5"** pocket  
depths  
to be used with:  
• Siding (0.75")  
• Polymer Shake (1")  
• Insulated Siding (1.25"-1.5")

**Individually wrapped  
in a 6 pack box**  
for clean jobsite arrival

## PREMIUM LOOK, SIMPLE UPKEEP (ALL BLOCKS & VENTS)



Our blocks and vents feature a premium stippled texture engineered for effortless cleaning. This finish not only creates a high-end, modern look but also makes maintenance a breeze.

# UNIVERSAL ELECTRICAL BOX

Applications: Receptacles, Exterior Lights, and more



## INSTALLS OVER WALL SUBSTRATE

The Universal Electrical Box is designed for installation over house wrap or exterior substrates, ensuring minimal wall penetration.

## INTEGRAL WIRE CLAMPS

Our design features integrated wire clamps that securely hold wires ranging from 12/3 to 14/2 firmly in place.

## SEE IT INSTALLED



See how easy we can make installing electrical boxes on your siding project.

**The Universal Electrical Box is sold separately from the Mounting Block to simplify quoting, inventory, and installation**



Cut along the receptacle score line on the back of the block

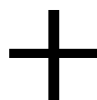

Attach Universal Electrical Box to wall



Install Mounting Block over Universal Electrical Box

# THE UNIVERSAL ELECTRICAL BOX ALIGNS WITH OUR MOUNTING BLOCK GUIDES

The Universal Electrical Box features grooves that align with guides on both the Standard and Large Mounting Blocks. Each block contains a score line to be used with the Universal Electrical Box. The Large Mounting Block has two sets of score lines and guides, enabling a centered or offset installation of the Universal Electrical Box. (the offset design is particularly beneficial for coach lights)

**Standard Mounting Block**



**Large Mounting Block**

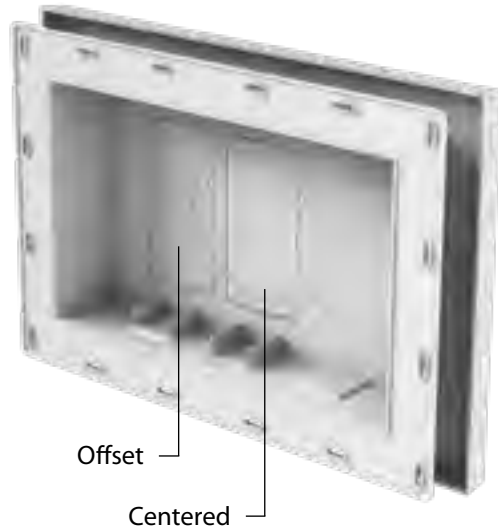

**Large Mounting Block**

**Large Mounting Block**

**Standard Mounting Block with Universal Electrical Box**

# SPLIT MOUNTING BLOCK

Applications: Hose penetrations, existing receptacles, AC lines, and more



**7.75" x 9.5"**  
Outer Dimension

**0.75"-1.5"** pocket depths  
to be used with:  
• Siding (0.75")  
• Polymer Shake (1")  
• Insulated Siding (1.25"-1.5")

**Individually wrapped  
in a 6 pack box**  
for clean jobsite arrival

## INNOVATIVE ONE-PIECE BACKPLATE



Our Split Block features a patent-pending one-piece backplate that simplifies installation and prevents parts from being misplaced.

## WIDE NAILING FLANGE (ALL MOUNTING BLOCKS)



Our mounting blocks are designed with ample space for hammering in nails and extra room on the flange for flashing or sealing tape.

# THE OFFSET HOLE PROVIDES FLEXIBILITY FOR BEST SPIGOT ACCESS



The split block features an offset hole, allowing for installation in either vertical direction. This flexibility allows installers to position the mounting block in the best orientation for each specific hose spigot, ensuring easy access to nozzles or handles.

## SIZED TO PERFECTLY FIT YOUR HAND



Our Split Block boasts the industry's largest opening, ensuring sufficient room for your hand to access hose spigots.

# UTILITY VENT OFFERING



**Louvered -  
MultiVersal Exh Vent**

**7.25" x 7.75"**  
Outer Dimension



Exhaust only  
Can be a **Dryer Vent**

**Sidewall & Soffit**  
Venting Applications

  
**4" tube diameter**

**0"-1" pocket depths**

to be used with:

- Soffit (0.5")
- Siding (0.75")
- Polymer Shake (1")

Ability to **Flush Mount**



**4"  
Hooded Vent**

**8.5" x 7.5"**  
Outer Dimension



Exhaust only  
Can be a **Dryer Vent**

**Sidewall**  
Venting Applications

  
**4" tube diameter**

**0.75"-1.5" pocket depths**

to be used with:

- Siding (0.75")
- Polymer Shake (1")
- Insulated Siding (1.25"-1.5")



**Hooded -  
MultiVersal I/E Vent**

**12.5" x 12.5"**  
Outer Dimension



Intake or Exhaust  
Can be a **Dryer Vent**

**Sidewall**  
Venting Applications

  
**4" or 6" tube diameter**

**0.75"-1.5" pocket depths**

to be used with:

- Siding (0.75")
- Polymer Shake (1")
- Insulated Siding (1.25"-1.5")



**Directional -  
MultiVersal I/E Vent**

**11" x 10.25"**  
Outer Dimension



Intake/ Exhaust

**Soffit, Sidewall,  
Foundation & Gable**  
Venting Applications

  
**3", 4", or 6" tube diameter**

**0.5"-1.5" pocket depths**

to be used with:

- Soffit (0.5")
- Siding (0.75")
- Polymer Shake (1")
- Insulated Siding (1.25"-1.5")

**Utility Vents (and Gable Vents) are individually boxed**  
for clean jobsite arrival

# ALL MULTIVERSAL™ VENTS: Deliver a flawless finish, whether you're covering imperfections from caulked edges or expansion joints

**FIBER CEMENT & ENGINEERED WOOD:** Baseplate design allows for caulking around the perimeter



**VINYL, ALUMINUM, & COMPOSITES:** Faceplate has flange to hide siding cuts & expansion joints



# LOUVERED - MULTIVERSAL™ EXHAUST VENT

Sidewall exhaust applications: Dryer vent, furnace, bathroom fan, range fan, and more



**7.25" x 7.75"**  
Outer Dimension



Exhaust only  
Can be a **Dryer Vent**

**Sidewall & Soffit**  
Venting Applications



**4" tube diameter**  
Open Area: 12.28 sq in

**0"-1" pocket depths**

to be used with:

- Soffit (0.5")
- Siding (0.75")
- Polymer Shake (1")

Ability to **Flush Mount**

**Individually boxed**  
for clean jobsite arrival

**Tube Extender**  
Included

## CAN BE INSTALLED FLUSH (OR WITH A SIDING POCKET)



Our faceplate features a traditional flange to conceal siding cuts, but our unique design also allows for flush installation—making it ideal for brick, soffit, and other applications with existing siding.

## FUNCTIONAL LOUVER WORKS ON SIDEWALL OR SOFFIT



Our patent-pending louver design is suitable for vertical (sidewall) or horizontal (soffit) configurations. With no magnets or springs, it can be used with dryers and is the preferred vent for 4-inch diameter exhaust applications.



Shown in color: E75 (popular in black: E72)



Shown in color: P28

# 4" HOODED EXHAUST VENT

Sidewall exhaust applications: Dryer vent, furnace, bathroom fan, range fan, and more



**8.5" x 7.5"**  
Outer Dimension



Exhaust only  
Can be a **Dryer Vent**

**Sidewall**  
Venting Applications



**4" tube diameter**  
Open Area: 12.28 sq in

**0.75"-1.5" pocket depths**

- to be used with:
- Siding (0.75")
  - Polymer Shake (1")
  - Insulated Siding (1.25"-1.5")

**Individually boxed**  
for clean jobsite arrival

**Tube Extender**  
Included

## SQUARE BACK-PLATE MAKES CUTTING SIDING EASY



Our square back-plate requires only straight cuts—no time wasted on the complicated angle cuts needed with other designs.

# DESIGNED TO STAY CLOSED, AND QUIET

During windstorms some hooded vent designs can experience “Flutter”. This is a banging sound created when the flapper repeatedly hits the back-plate.

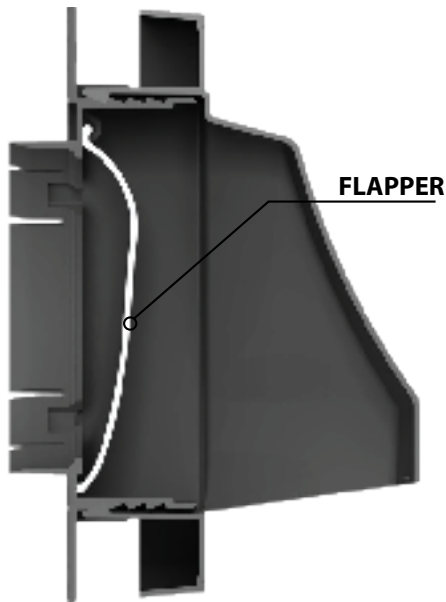

## VENT CROSS SECTION

To the left is a cross-section of our 4-inch Hooded Exhaust Vent, with the flapper highlighted in white. This essential component prevents both unwanted critter entry and the backflow of air.

## ENGINEERED TO STAY CLOSED

We intentionally offset the flapper's center of gravity by roughly 10 degrees from its natural hanging position, ensuring gentle pressure keeps it closed.

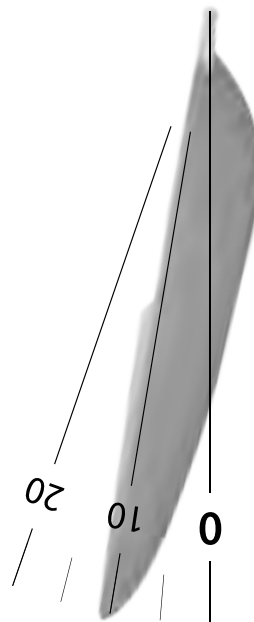

## FLAPPER DESIGN MATTERS



Watch this video to see how the flapper design uses pressure from its own weight to stay closed.

# HOODED - MULTIVERSAL™ I/E VENT

Sidewall applications: Intake (furnace, hot water heater, and more) or exhaust (dryer vent, furnace, bathroom fan, range fan, and more)



**12.5" x 12.5"**  
Outer Dimension



Intake or Exhaust  
Can be a **Dryer Vent**

**Sidewall**  
Venting Applications



**4" or 6" tube diameter**  
Max Open Area: 28.3 sq in

**0.75"-1.5" pocket depths**  
to be used with:  
• Siding (0.75")  
• Polymer Shake (1")  
• Insulated Siding (1.25"-1.5")

**Individually boxed**  
for clean jobsite arrival

## LARGER SIZE PROVIDES SUFFICIENT OPEN AREA FOR 6" SYSTEMS



Our vent is larger than competitive designs, providing ample open area for a 6-inch HVAC system. This ensures that airflow at the exit is never restricted.

## NEVER HOLD-UP A JOB AGAIN



Ever had a job delayed by ordering the wrong utility vent? Keep a few of these on hand, and you'll always have the perfect solution for your sidewall venting needs—no matter the tube size, siding type, or airflow direction.

# CONVERT THE VENT'S FUNCTIONALITY FROM EXHAUST TO INTAKE BY REMOVING THE FLAPPER'S SNAP-ON COVER

(SNAP-ON COVER INCLUDED)

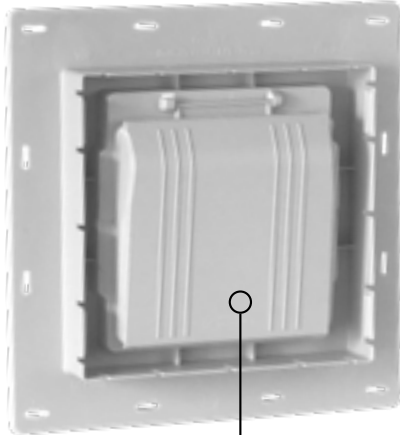

## EXHAUST

With the cover attached, the system is ready for exhaust flow; its center of gravity seats it securely against the backplate, virtually eliminating flutter.

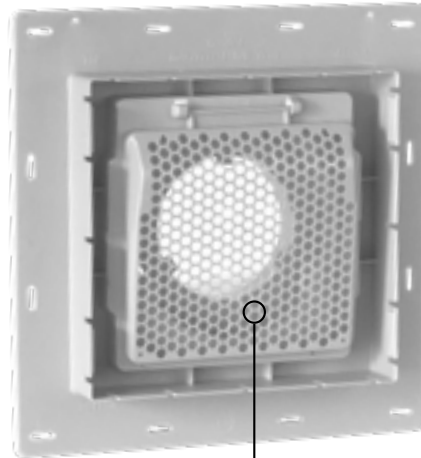

## INTAKE

For intake applications, simply remove the snap-on cover. Screw holes in each bottom corner add extra animal protection.



## ACCEPTS MULTIPLE TUBE DIAMETERS

This utility vent accommodates various tube sizes, ensuring you have the right solution for any ducting application.



### 4" opening

Ready for 4" applications

### 6" opening

Cut along scribe line for 6" applications



# DIRECTIONAL - MULTIVERSAL™ I/E VENT

Soffit & sidewall applications: Intake (furnace, hot water heater, and more) or exhaust (furnace, hot water heater, bathroom fan, range fan, and more)



**11" x 10.25"**  
Outer Dimension



Intake/ Exhaust

**Soffit, Sidewall,  
Foundation & Gable**  
Venting Applications



**3", 4", or 6"** tube  
diameter  
Max Open Area: 28.3 sq in

**0.5"-1.5"** pocket  
depths

to be used with:

- Soffit (0.5")
- Siding (0.75")
- Polymer Shake (1")
- Insulated Siding (1.25"-1.5")

**Individually boxed**  
for clean jobsite arrival

## DIRECTIONAL LOUVERS DIRECT AIR AWAY



The fixed, directional louvers ensure that potentially hot, humid air—prone to causing condensation issues and mold—is directed away from both the structure and soffit intakes. This design makes for an excellent choice in soffit venting compared to many conventional intake/exhaust systems.

# A VERSATILE INTAKE/EXHAUST VENT IDEAL FOR SOFFITS OR SIDEWALLS

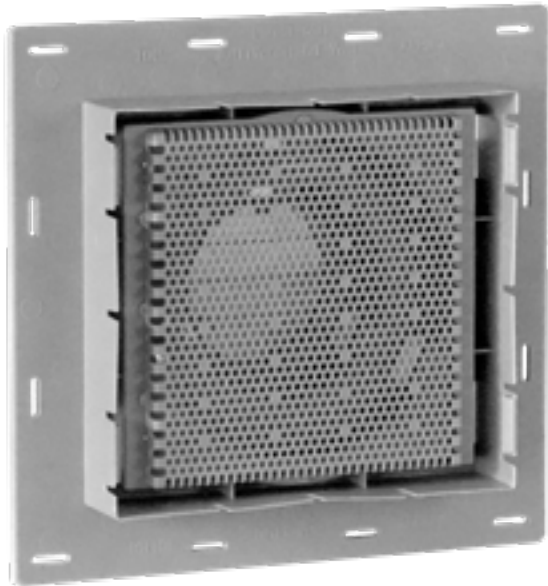

## SOFFIT/SIDEWALL APPLICATIONS

With pocket depths ranging from 0.5"-1.5", our design can be used with both sidewall and soffit installations.

## GABLE VENT APPLICATIONS

Simply cut along the scribe line for the 6" opening to use as a gable vent.

## FOUNDATION VENT APPLICATIONS

Use the 6" opening when a foundation vent is needed in the wall substrate. Multiple vents can provide more uniform venting under a structure.

## EASY SCREEN MAINTENANCE

 Our screen can be easily accessed by removing the face plate. This helps ensure maintenance and cleaning is straightforward.

## ACCEPTS MULTIPLE TUBE DIAMETERS

For your convenience, this utility vent accommodates various tube sizes, ensuring you have the right solution for any ducting application.

### **3" opening**

Ready for 3" applications

### **4" opening**

Cut along scribe line for 4" applications

### **6" opening**

Cut along scribe line for 6" applications

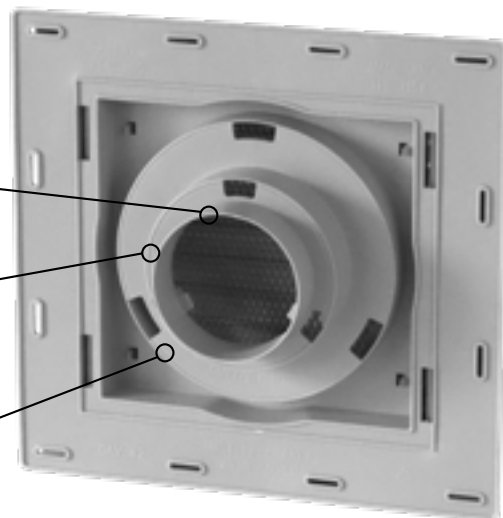

# 17" x 23" GABLE VENT

Our most popular gable vent, used for functional & decorative gable vent installations



**16.5" x 22.5"**  
Outer Dimension

**48 sq in**  
Open Area

**0.75"-1.5"** pocket depths  
to be used with:  
• Siding (0.75")  
• Polymer Shake (1")  
• Insulated Siding (1.25"-1.5")

**Individually boxed**  
for clean jobsite arrival

## ABILITY TO FLUSH MOUNT (DECORATIVE ONLY)



The faceplate can be flush mounted on siding. Simply install it without the backplate, just like a shutter.

# WIDE LOUVERS FOR A DISTINCTIVE CRAFTSMAN-INSPIRED LOOK



This modern design has wide trim and louvers, providing a premium, modern appearance. Elevate your home with this gable accent.

## WORKS WITH MANY SIDING TYPES

**Vinyl, Insulated Vinyl, Aluminum, & Composites:**

Faceplate has flange to hide siding cuts.

**Fiber Cement & Engineered Wood:** Baseplate design allows for caulking around the perimeter.

## MOLDED SCREEN



Our 17x23 Gable Vent features a molded mesh screen, delivering robust performance and exceptional durability.

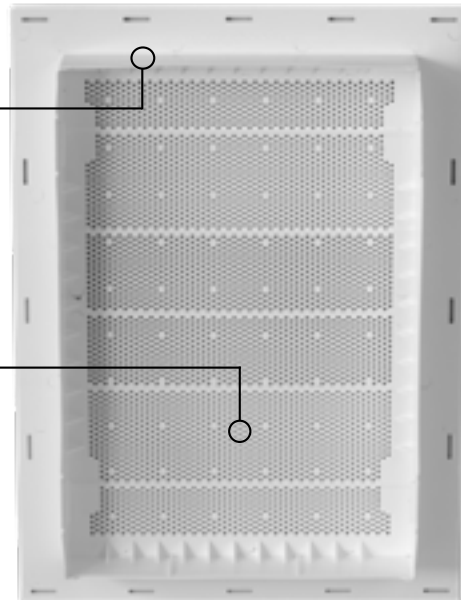

# RECTANGLE GABLE VENTS

A modern design for attic ventilation



**17"x23"**  
(Customer Favorite)

17"x22.5"  
Outer Dimension

11"x16"  
Recommended  
Hole Opening

Open Area:  
**48<sup>SQ IN</sup>**

Plastic  
**Molded**  
Screen

**0.75"-1.5"** pocket  
depths  
to be used with:  
• Siding (0.75")  
• Polymer Shake (1")  
• Insulated Siding (1.25"-1.5")



**12"x18"**

12"x18"  
Outer Dimension

10"x16"  
Recommended  
Hole Opening

Open Area:  
**38<sup>SQ IN</sup>**

Glued  
Nylon  
Screen

**0.75"** pocket  
depth  
to be used with:  
• Siding (0.75")



**Directional  
MultiVersal Vent**

10"x10"  
Outer Dimension

**6"**  
Diameter  
Recommended  
Hole Opening

Open Area:  
**28.3<sup>SQ IN</sup>**

Plastic  
**Molded**  
Screen

**0.5"-1.5"** pocket  
depths  
to be used with:  
• Siding (0.75")  
• Polymer Shake (1")  
• Insulated Siding (1.25"-1.5")

# ROUND & OCTAGON GABLE VENTS

A classic design for attic ventilation

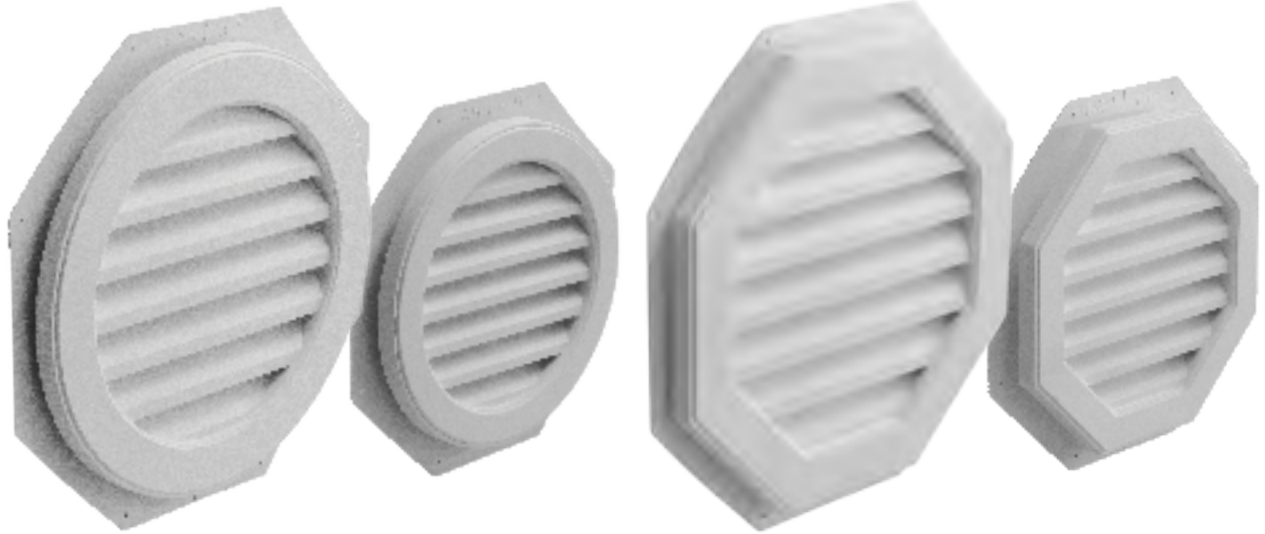

## 22" Round

21.75"  
Diameter  
Outer Dimension

19"  
Diameter  
Recommended  
Hole Opening

Open Area:  
43<sup>SQ IN</sup>

Glued  
Nylon  
Screen

**0.75" pocket depth**  
to be used with:  
• Siding (0.75")

## 16" Round

16"  
Diameter  
Outer Dimension

13.5"  
Diameter  
Recommended  
Hole Opening

Open Area:  
31<sup>SQ IN</sup>

Glued  
Nylon  
Screen

**0.75" pocket depth**  
to be used with:  
• Siding (0.75")

## 22" Octagon

21.75"  
Flat to Flat  
Outer Dimension

19"  
Diameter  
Recommended  
Hole Opening

Open Area:  
45<sup>SQ IN</sup>

Glued  
Nylon  
Screen

**0.75" pocket depth**  
to be used with:  
• Siding (0.75")

## 16" Octagon

16"  
Flat to Flat  
Outer Dimension

13.5"  
Diameter  
Recommended  
Hole Opening

Open Area:  
32<sup>SQ IN</sup>

Glued  
Nylon  
Screen

**0.75" pocket depth**  
to be used with:  
• Siding (0.75")

# PART NUMBERS

## STANDARD SHUTTERS:

Nominal height	Raised Panel		Open Louver		Board & Batten	
	12" width	14.5" width	12" width	14.5" width	3 board joined (11" width)	4 board joined (14.5" width)
31"	40120310***	40140310***	41120310***	41140310***	42110310***	42140310***
35"	40120350***	40140350***	41120350***	41140350***	42110350***	42140350***
39"	40120390***	40140390***	41120390***	41140390***	42110390***	42140390***
43"	40120430***	40140430***	41120430***	41140430***	42110430***	42140430***
47"	40120470***	40140470***	41120470***	41140470***	42110470***	42140470***
51"	40120510***	40140510***	41120510***	41140510***	42110510***	42140510***
55"	40120550***	40140550***	41120550***	41140550***	42110550***	42140550***
59"	40120590***	40140590***	41120590***	41140590***	42110590***	42140590***
63"	40120630***	40140630***	41120630***	P1140630***	42110630***	42140630***
67"	40120670***	40140670***	41120670***	41140670***	42110670***	42140670***
71"	40120710***	40140710***	41120710***	41140710***	42110710***	42140710***
75"	40120750***	40140750***	41120750***	41140750***	42110750***	42140750***
81"	40120810***	40140810***	41120810***	41140810***	42110810***	42140810***

- \*\*\* is a placeholder for the 3 digit color number (please see shutter colors on the next page)
- For custom shutter heights, contact Pontiac Trail. Custom heights available: 28-81" in 0.5" increments

## BLOCKS & VENTS:

Mounting Blocks:	PN:
Standard Mounting Block - 1 piece (6pcs/carton)	33040601***
Large Mounting Block - 1 piece (6pcs/carton)	35061001***
Split Mounting Block - 1 piece (6pcs/carton)	38050501***
Universal Electrical Box - 1 piece (6pcs/carton)	39050601555

- Must order in multiples of 6 pieces (the carton quantity)
- A Broken Box Fee applies to each item not ordered in carton quantity
- Products in the 6 piece carton are individually wrapped
- Full color offering (\*\*\*) is a placeholder for the 3 digit color number)

Gable Vents:	PN:
17"x23" Gable Vent - (1pc/carton)	12172301***
12"x18" Gable Vent - (1pc/carton)	13121801A43
(10"x10") Directional MultiVersal Vent - (1pc/carton)	25101001***
16" Round Gable Vent - (1pc/carton)	13164401A43
22" Round Gable Vent - (1pc/carton)	13224401A43
16" Octagon Gable Vent - (1pc/carton)	13168801A43
22" Octagon Gable Vent - (1pc/carton)	13228801A43

- \*\*\* is a placeholder for the 3 digit color number
- Part numbers ending in A43 are only available in "A43 White"

Utility Vents:	PN:
4" Hooded Vent - (1pc/carton)	24080701***
Hooded - MultiVersal I/E Vent - (1pc/carton)	26121101***
Directional - MultiVersal I/E Vent - (1pc/carton)	25101001***
Louvered - MultiVersal Exh Vent - (1pc/carton)	23070801***

- Full color offering (\*\*\*) is a placeholder for the 3 digit color number)

Accessories & Hardware:	PN:
Shutter Plugs - 1 Kit (12/Kit)	46110012***
Shutter Screws & Caps - Kit (12/Kit)	46220012***
Replacement 3B Batten (Single Batten)	46453001***
Replacement 4B Batten (Single Batten)	46454001***
4" Vent Screen - 1 piece (6pcs/carton)	24080710999
6" Metal Tube - 1 piece (6pcs/carton)	20123456999

# SHUTTER COLOR PALETTE

Printed colors may not accurately represent molded colors, please ask to see a color guide for the exact color.



Black Cosmos (050)

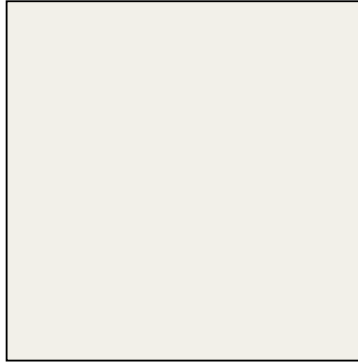

Dover White (930)

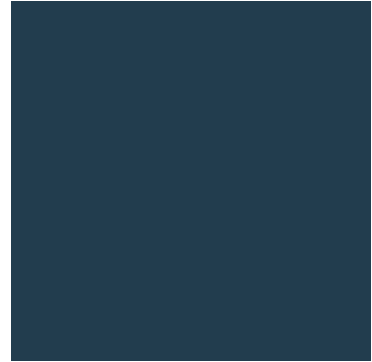

Navy Night Sky (104)

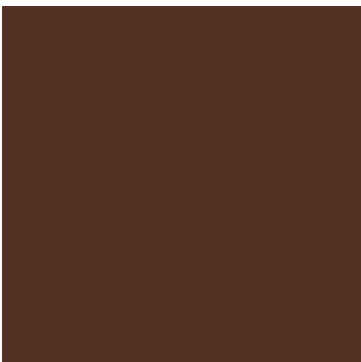

Dark Cherry Mocha (090)



Cornerstone Grey (410)



Coastal Sand Dune (730)

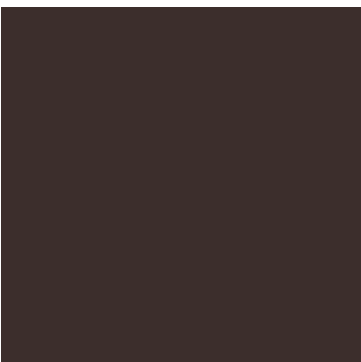

Coffee Bean (035)



Heathered Spruce (046)

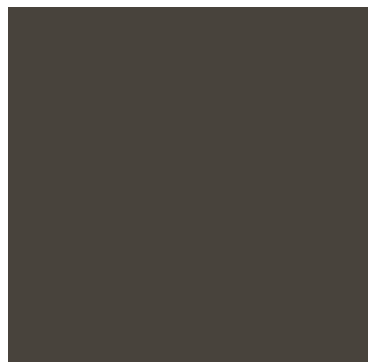

Stone Mason Brown (022)

## COLOR MATCHES FOR ALL SIDING



We offer hundreds of siding color matches in our blocks and vents. Simply scan the QR code to view the full list of siding manufacturers for which we provide color matches.

# PONTIAC TRAIL®

HOME DETAILS TO LIVE BY



**Scan the QR code with your smartphone camera to access:**

- Marketing Literature
- Sizing & Installation Guides
- Limited Lifetime Warranty



[orders@pontiactrail.com](mailto:orders@pontiactrail.com)  
[support@pontiactrail.com](mailto:support@pontiactrail.com)  
800.558.2205  
[www.pontiactrail.com](http://www.pontiactrail.com)